



Product Features



High Module Conversion Efficiency

Solar cells average efficiency 19.0%
Module efficiency up to 15.9%



Positive Tolerance

Guaranteed positive tolerance from 0~3%
ensures power output reliability



Strong Compressive Strength

Entire module certified to withstand high wind loads of 2.4kPa and snow loads of 5.4kPa



Outstanding Performance

Excellent performance under weak light environments



Premium Quality of Raw Materials

Premium quality of 9-N poly-silicon as raw material, advanced process and the authorized agency test guarantees the reliability of modules



Junction Box

Superior conductivity, top protection class, good anti-weathering & sealing



Leading Warranty in PV Industry

- 25-year transferrable power output warranty: 12 years/90%, 18years/85%, 25years/80%*
- Based on nominal power
- 10 years material and workmanship warranty

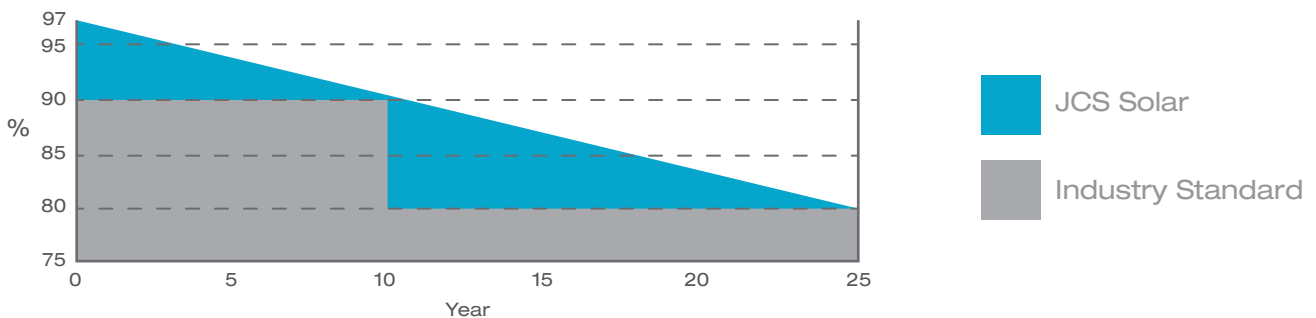

* Please refer to JCS Solar Product Warranty for details.

JCS SOLAR CO.,LTD SALES CONTACTS

ADD: #1711, WANGJIAO PLAZA,NO.175 EAST YAN'AN ROAD, HUANGPU DISTRICT, 200002,SHANGHAI, CHINA

TEL: +86 (0)21 3307 0665

FAX: +86 (0)21 3307 0663-205

EMAIL: SALES@JCSSOLAR.COM

HTTP://WWW.JCSSOLAR.COM

Electrical Characteristics

Module Type	JCSM290M-72	JCSM295M-72	JCSM300M-72	JCSM305M-72	JCSM310M-72
Optimum Operating Voltage (Vmax/V)	35.8	35.83	36.14	37.1	37.39
Optimum Operating Current (Impp/A)	8.11	8.2	8.32	8.43	8.54
Open-Circuit Voltage (Voc/V)	44.5	44.61	45.2	45.48	46.3
Short-Circuit Current (Isc/A)	8.68	8.76	8.87	8.9	9.01
Maximum Power at STC (Pmax/W)	290	295	300	305	310
Module Efficiency (%)	14.9%	15.1%	15.4%	15.7%	15.9%
Operating Module Temperature (°C)	-40°C to +85°C				
Maximum System Voltage (V)	1000V DC				
Maximum Series Fuse Rating (A)	15A				
Power Tolerance (%)	0/+3				
STC: Irradiance 1000W/m ² , module temperature 25°C, AM1.5; Power measurement tolerance:±3%					

Dimensions of PV Module 305W

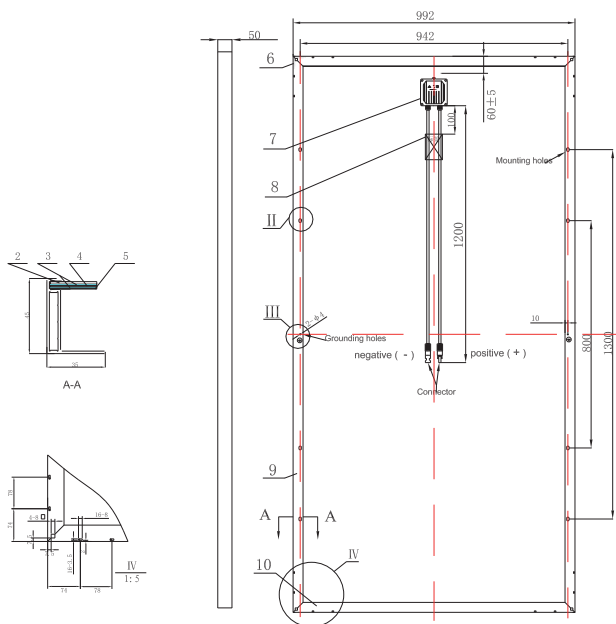

Current-Voltage & Power-Voltage Curve 305W

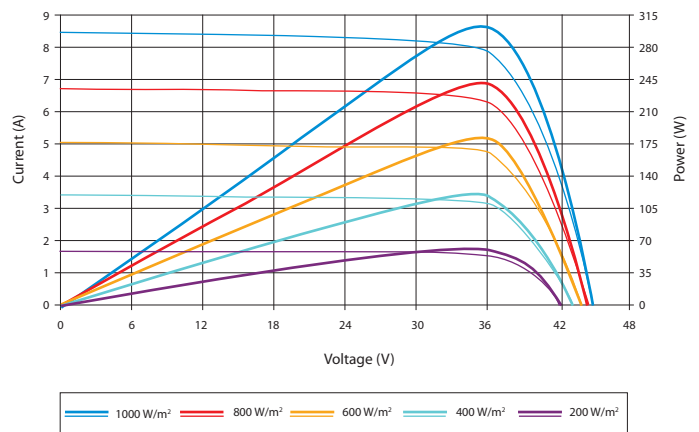

Temperature Characteristics

Nominal Operating Cell Temperature(NOCT)	45 °C
Temperature Coefficient of Pmax	-0.45% / °C
Temperature Coefficient of Voc	-0.35% / °C
Temperature Coefficient of Isc	0.060% / °C

Mechanical Characteristics

Solar Cell	monocrystalline(156*156mm)
No.of Cells	72(6*12)
Dimensions	1957*992*50mm
Weight	22.5kg
Front Glass	3.2mm tempered glass
Frame	anodized aluminum alloy
Junction Box	TUV certified/IP65/IP67
Output Cables (length/cross-sectional area)	1200mm/4.0mm ²

Packing Specifications

Container	20'GP	40'GP	40'HQ
Pieces per pallet	37	37	46
Pallets per container	5	12	12
Pieces per container	185	444	552
MC4 Connectors (Option)	20	30	50

Remark

For more product information, please contact us.

